

4. Equipment and Packaging

4.1. Front case labelling

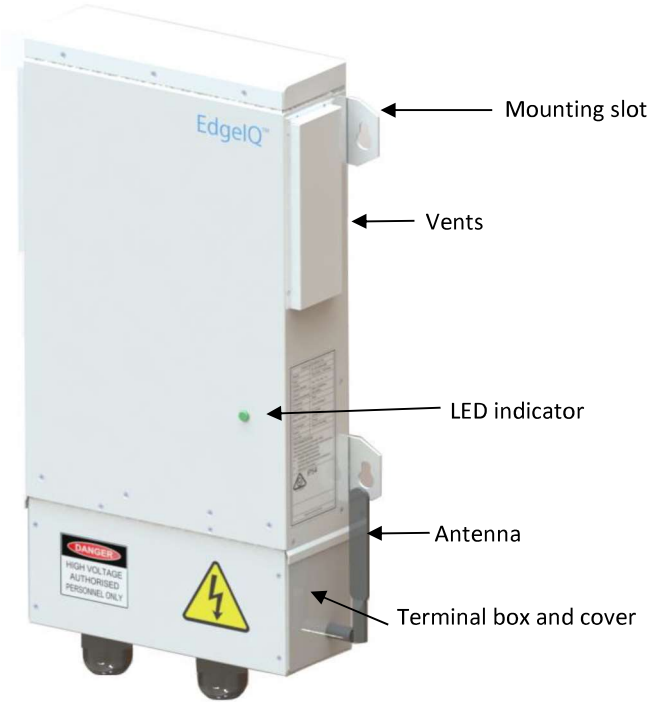

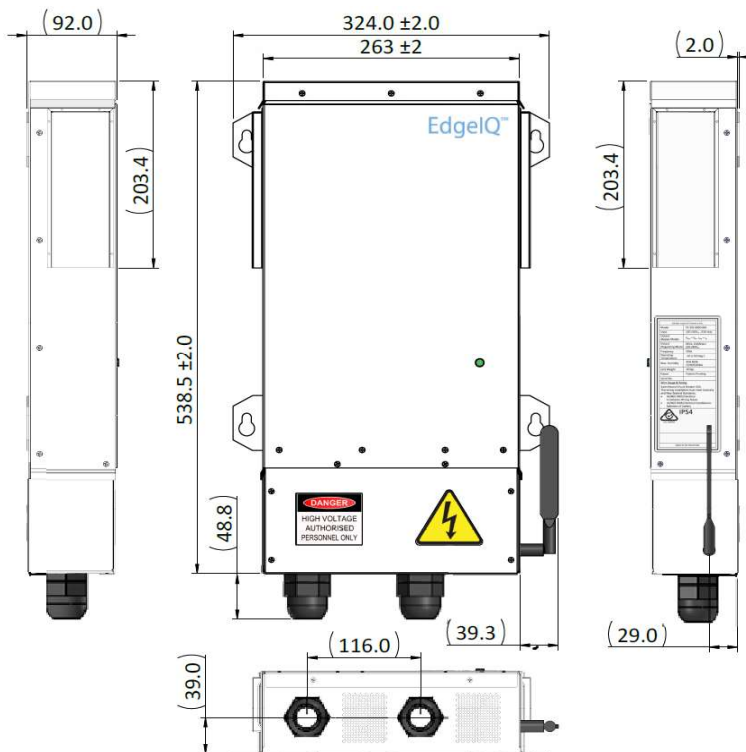







4.2. Dimensions



4.3. Packing list

Do not commence installation of the EdgeIQ if there is any visible breakage, loose connections and/or missing parts. Any missing or broken components from the below list must be notified to Edge Electronics *immediately* after unpacking the unit.

Items		Quantity
EE-202-0050 Series Single phase EdgeIQ		1 pc
1. CTSA016 current transformer (Operating up to 50 A) NB: Applicable only for the output of the solar inverter		1 pc
2. Cable glands		2 pcs
3. Installation manual		1 pc
4. Mounting screws (Alternative: Wall Anchor)		4 sets
5. Communication kit (Optional):		
a. Modem and SIM (pre-installed)		1 pc
b. Antenna		1 pc
c. Antenna cable		1 pc